

## DIO233X/B

### Ultra Low Vos, Low Power Amplifier

#### Features

- Ultra low  $V_{OS}$ : DIO233X:15 $\mu$ V(Max)  
DIO233XB:35 $\mu$ V(Max)
- Low Power: 1.0 $\mu$ A(typ.)
- Unity Gain Stable
- Gain Bandwidth Product: 30kHz(typ.)
- Wide supply range: 1.8V to 5.5V
- Available in SOT23-5, SOT23-6, SOIC-8, MSOP-8, SOIC-14 and TSSOP-14 packages
- Temperature Range:-40°C to 125°C

#### Descriptions

DIO233X/B is a family of ultra low  $V_{OS}$  operational amplifier, with rail-to-rail CMOS input/output and single/dual channels selectable. DIO233X/B family has a gain-bandwidth product of 30kHz(typ.), wide operating supply voltage from 1.8V to 5.5V and broad output voltage swing.

DIO233X/B consumes ultra low power, with each channel 1.0 $\mu$ A(typ.) of bias current, which makes DIO233X/B be ideal for battery powered device, temperature-sense device, etc.

#### Typical Applications

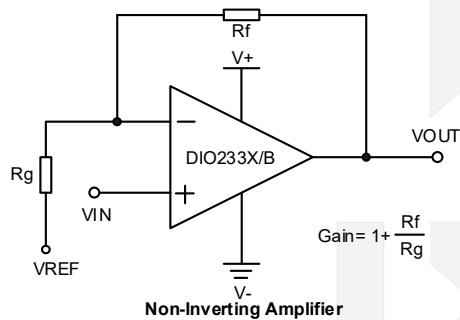

#### Applications

- Toll Booth Tags
- Wearable Products
- Battery Current Monitoring
- Sensor Conditioning
- Battery Powered

## Ordering Information

Order Part Number	Top Marking		T <sub>A</sub>	Package	
DIO2331ST5	31YW	Green or RoHS	-40 to 125°C	SOT23-5	Tape & Reel, 3000
DIO2331BST5	31YW	Green or RoHS	-40 to 125°C	SOT23-5	Tape & Reel, 3000
DIO2331SO8	DIO2331	Green or RoHS	-40 to 125°C	SOIC-8	Tape & Reel, 2500
DIO2331BSO8	DIO2331	Green or RoHS	-40 to 125°C	SOIC-8	Tape & Reel, 2500
DIO2331MP8	DIO2331	Green or RoHS	-40 to 125°C	MSOP-8	Tape & Reel, 3000
DIO2331BMP8	DIO2331	Green or RoHS	-40 to 125°C	MSOP-8	Tape & Reel, 3000
DIO2331DST6	31DW	Green or RoHS	-40 to 125°C	SOT23-6	Tape & Reel, 3000
DIO2331DBST6	31DW	Green or RoHS	-40 to 125°C	SOT23-6	Tape & Reel, 3000
DIO2332SO8	DIO2332	Green or RoHS	-40 to 125°C	SOIC-8	Tape & Reel, 2500
DIO2332BSO8	DIO2332	Green or RoHS	-40 to 125°C	SOIC-8	Tape & Reel, 2500
DIO2332MP8	DIO2332	Green or RoHS	-40 to 125°C	MSOP-8	Tape & Reel, 3000
DIO2332BMP8	DIO2332	Green or RoHS	-40 to 125°C	MSOP-8	Tape & Reel, 3000
DIO2333SO8	DIO2333	Green or RoHS	-40 to 125°C	SOIC-8	Tape & Reel, 2500
DIO2333BSO8	DIO2333	Green or RoHS	-40 to 125°C	SOIC-8	Tape & Reel, 2500
DIO2333MP8	DIO2333	Green or RoHS	-40 to 125°C	MSOP-8	Tape & Reel, 3000
DIO2333BMP8	DIO2333	Green or RoHS	-40 to 125°C	MSOP-8	Tape & Reel, 3000
DIO2334SO14	DIO2334	Green or RoHS	-40 to 125°C	SOIC-14	Tape & Reel, 2500
DIO2334BSO14	DIO2334	Green or RoHS	-40 to 125°C	SOIC-14	Tape & Reel, 2500
DIO2334TP14	DIO2334	Green or RoHS	-40 to 125°C	TSSOP-14	Tape & Reel, 2500
DIO2334BTP14	DIO2334	Green or RoHS	-40 to 125°C	TSSOP-14	Tape & Reel, 2500

## Ordering Information Complimentary Note

Ordering Code = Part No. + Package Code

DIO2331/1B/1D/1DB  
DIO2332/2B  
DIO2333/3B  
DIO2334/4B

ST5: stands for SOT23-5  
ST6: stands for SOT23-6  
SO8: stands for SOIC-8  
MP8: stands for MSOP-8  
SO14: stands for SOIC-14  
TP14: stands for TSSOP-14

## Pin Assignments

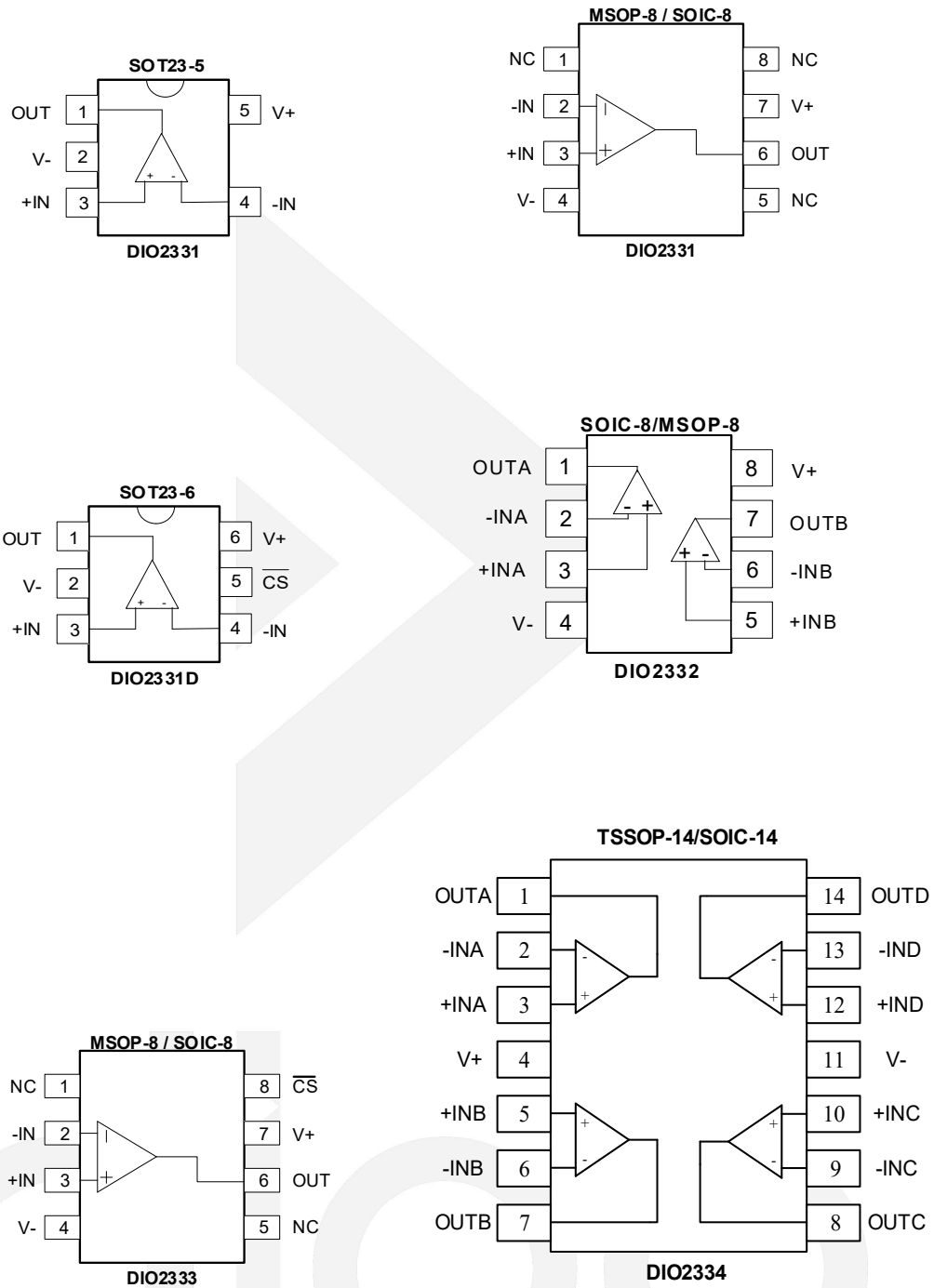

Figure 1 Top View

## Pin Description

Pin name	Description
V+	Positive supply
V-	Negative supply
+INX	Positive Input
-INX	Negative Input
OUTX	Output
NC	No connect
$\overline{\text{CS}}$	Power saving Chip Select

## Absolute Maximum Ratings

Stresses beyond those listed under "Absolute Maximum Rating" may cause permanent damage to the device. These are stress ratings only and functional operation of the device at these or any other condition beyond those indicated in the operational sections of the specifications is not implied. Exposure to absolute maximum rating conditions for extended periods may affect device reliability.

Parameter	Rating	Unit	
V+ – V-	7	V	
Current at Input Pins	±2	mA	
Input Voltage	(V-)-0.3V to (V+)+0.3V	V	
Difference Input Voltage	V+ – V-		
Output Short-Circuit Current	Continuous		
Current at Output and Supply Pins	±30	mA	
Storage Temperature	-65 to 150	°C	
Maximum Junction Temperature(T <sub>J</sub> )	150	°C	
ESD protection on all pins (HBM)	7.5	kV	
Package Thermal Resistance(θ <sub>JA</sub> )	SOT23-5	256	°C/W
	SOIC-8	163	°C/W
	MSOP-8	206	°C/W
	SOIC-14	120	°C/W
	TSSOP-14	100	°C/W
Operating Temperature Range(T <sub>A</sub> )	-40~125	°C	

## DC Electrical Characteristics

Unless otherwise indicated,  $V_+ = 1.8V$  to  $5.5V$ ,  $V_- = 0$ ,  $T_A = 25^\circ C$ ,  $V_{CM} = V_+/2$ ,  $R_L = 1M\Omega$  to  $V_{CM}$ .

Symbol	Parameter	Conditions	Min.	Typ.	Max.	Unit
<b>Input Offset</b>						
$V_{OS}$	Input Offset Voltage	$V_+ = 1.8 \sim 5.5V, V_{CM} = (V_+)/2$	DIO233X	-15	15	$\mu V$
			DIO233XB	-35	35	
$\frac{\Delta V_{OS}}{\Delta T_A}$	Input Offset Drift with Temperature	$T_A = -40^\circ C$ to $125^\circ C, V_+ = 1.8 \sim 5.5V, V_{CM} = (V_+)/2$		$\pm 0.15$		$\mu V/^\circ C$
PSRR	Power Supply Rejection Ratio	$V_{CM} = (V_+)/2$	100	110		dB
<b>Input Bias Current and Impedance</b>						
$I_B$	Input Bias Current	$T_A = 25^\circ C$		$\pm 1.0$		pA
		$T_A = 85^\circ C$		60		pA
		$T_A = 125^\circ C$		2000		pA
$I_{OS}$	Input Offset Current			$\pm 1.0$		pA
$Z_{CM}$	Common Mode Input Impedance			$10^{13}    6$		$\Omega    pF$
$Z_{DIFF}$	Differential Input Impedance			$10^{13}    6$		$\Omega    pF$
<b>Common Mode</b>						
$V_{CMR}$	Common Mode Input Voltage Range		(V-) 0.1		(V+) 0.1	V
CMRR	Common Mode Rejection Ratio	$V_{CM}$ from (V-)-0.1 to (V+)+0.1	100	110		dB
<b>Open-Loop Gain</b>						
$A_{OL}$	DC Open-Loop Gain (Large Signal)	$0.2V < V_{OUT} < (V_+ - 0.2V), R_L = 50k\Omega$ to $V_L$		120		dB
<b>Output</b>						
$V_{OL}$	Output Voltage Low	$V_+ = 5V, R_L = 50k$ to $V_+/2$		4.8		mV
$V_{OH}$	Output Voltage High	$V_+ = 5V, R_L = 50k$ to GND		4.994		V
$I_{SC}$	Output Short-Circuit Current	$V_+ = 1.8V$		3		mA
		$V_+ = 5V$		30		
<b>Power Supply</b>						
THD		$V_+ = 5V, V_{PP} = 2V, R_L = 50k,$ Frequency = 100Hz		0.13		%

		V+=5V, V <sub>PP</sub> =2V, R <sub>L</sub> =50k, Frequency=200Hz		0.26		
		V+=5V, V <sub>PP</sub> =2V, R <sub>L</sub> =50k, Frequency=250Hz		0.33		
		V+=5V, V <sub>PP</sub> =2V, R <sub>L</sub> =50k, Frequency=500Hz		0.62		
V+	Supply Voltage		1.8		5.5	V
I <sub>Q</sub>	Quiescent Current per Amplifier	I <sub>O</sub> =0, V <sub>CM</sub> =(V+)/2, V+=5.0V		1.0		μA

Specifications subject to change without notice.

## AC Electrical Characteristics

Unless otherwise indicated, T<sub>A</sub>=25°C, V+=1.8 to 5.5V, V-=0, V<sub>CM</sub>=V+/2, C<sub>L</sub>=60pF, R<sub>L</sub>=1MΩ to V<sub>CM</sub>.

Symbol	Parameter	Conditions	Min.	Typ.	Max.	Unit
<b>AC Response</b>						
GBWP	Gain Bandwidth Product			30		kHz
PM	Phase Margin	G=1V/V		65		°
SR	Slew Rate			10		V/ms
<b>Noise</b>						
Eni	Input Noise Voltage	f=0.1Hz to 10Hz		3.9		μVp-p
e <sub>ni</sub>	Input Noise Voltage Density	f=1kHz		165		nV/√Hz
i <sub>ni</sub>	Input Noise Current Density	f=1kHz		0.6		fA/√Hz

Specifications subject to change without notice.

## Typical Performance Characteristics

I<sub>CC</sub> VS V<sub>CC</sub>

Supply Current Vs. Supply Voltage

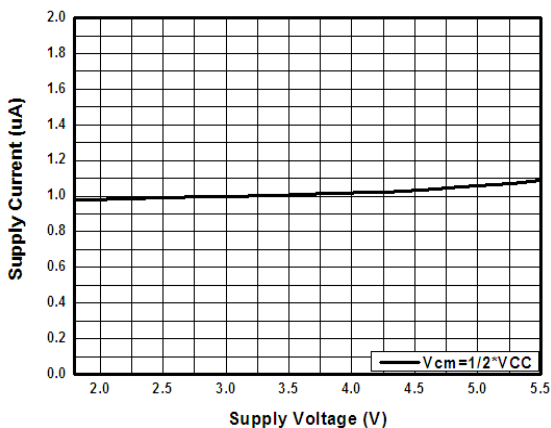

I<sub>CC</sub> VS TEMP

Supply Current Vs. Temperature

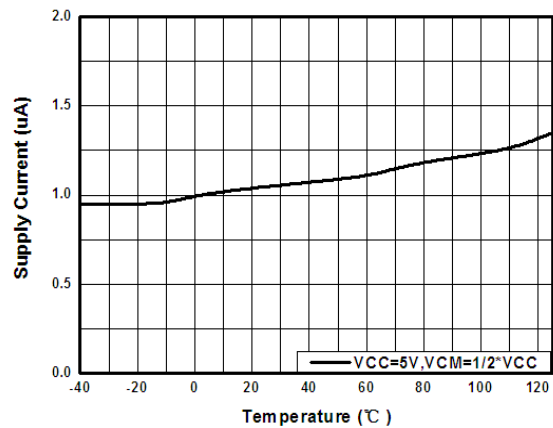

### V<sub>os</sub> VS V<sub>CC</sub>

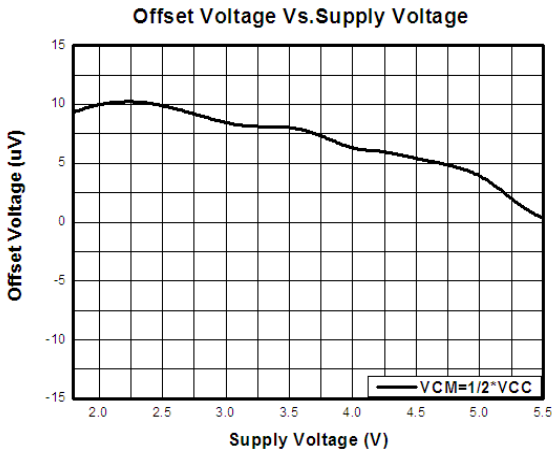

### V<sub>os</sub> VS V<sub>CM</sub>

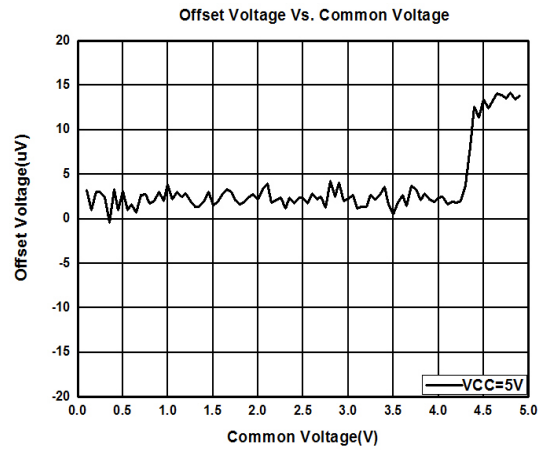

### V<sub>os</sub> VS TEMP

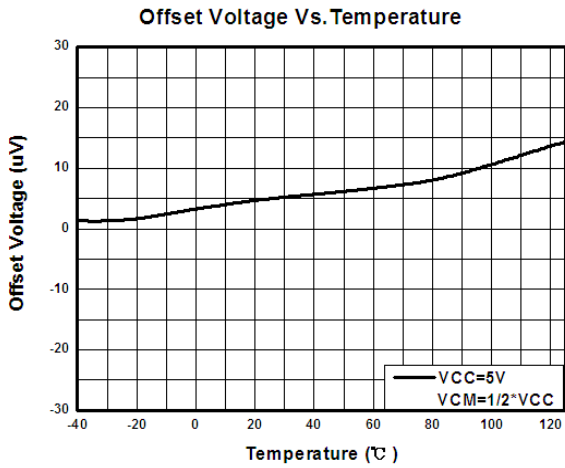

### Large-Signal Response

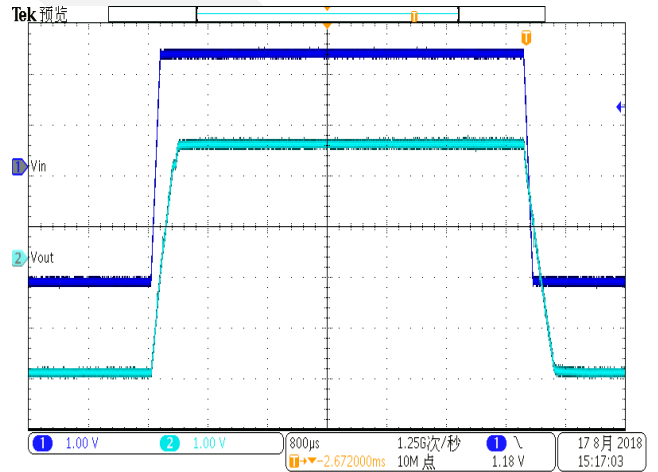

### Small-signal response (CL=No Cap)

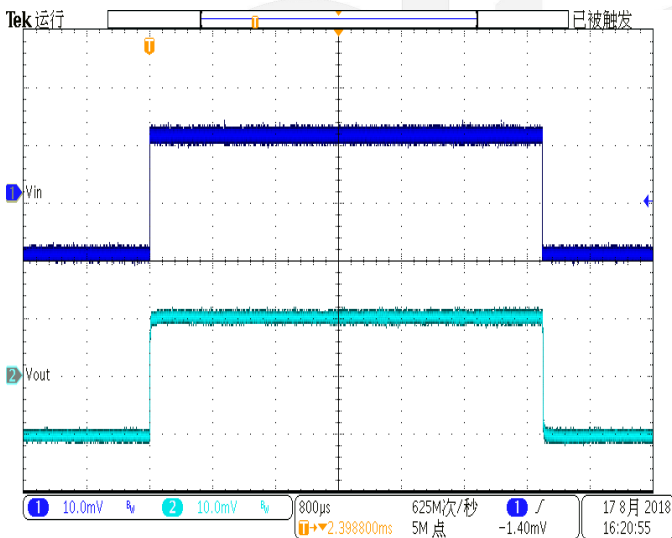

### Small-signal response (CL=200p Cap)

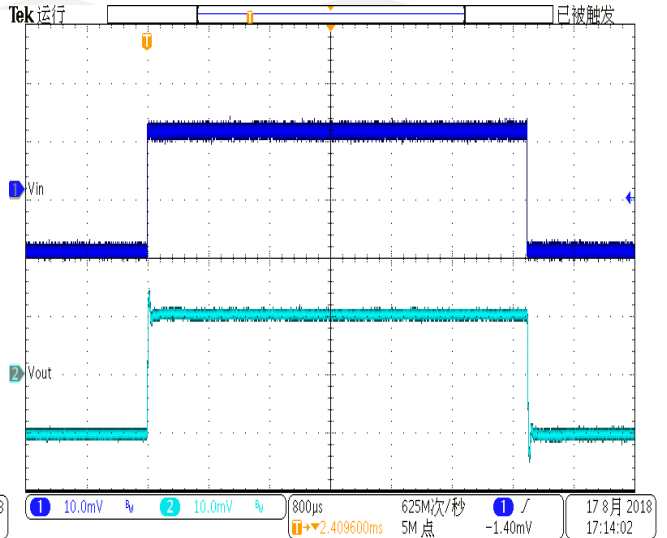

## CONTACT US

Dioo is a professional design and sales corporation for high-quality and performance analog semiconductors. The company focuses on industry markets, such as, cell phone, handheld products, laptop, and medical equipment and so on. Dioo's product families include analog signal processing and amplifying, LED drivers and charger IC. Go to <http://www.dioo.com> for a complete list of Dioo product families.

For additional product information, or full datasheet, please contact with our Sales Department or Representatives.

