

## DIO6002

# High-Efficiency 1.5MHz, 1.2A Continuous, 1.5A Peak, Synchronous Step Down Converter

### Features

- 2.5-5.5V input voltage range
- 1.2A continuous, 1.5A peak load current
- Low  $R_{DS(ON)}$  for internal switches (top/bottom) 230m $\Omega$ /170m $\Omega$ , 1.2A
- 40 $\mu$ A typical quiescent current
- High light load efficiency
- High switching frequency 1.5MHz minimizes the external components
- Internal soft start limits the inrush current
- 100% dropout operation
- Green package:  
SOT23-5 is pin compatible.

### Applications

- Portable Navigation Device
- Set Top Box
- USB Dongle
- Media Player
- Smart phone

### Descriptions

The DIO6002 is high-efficiency, high frequency synchronous step-down DC-DC regulator ICs capable of delivering up to 1.5A peak load current within 2.5V-5.5V input voltage.

The DIO6002 family integrate main switch and synchronous switch with very low  $R_{DS(ON)}$  to minimize the conduction loss. Low output voltage ripple and small external inductor and capacitor sizes are achieved with greater than 1.5MHz switching frequency.

The DIO6002 is available in SOT23-5 package, requires only a minimal number of external components.

### Function Block

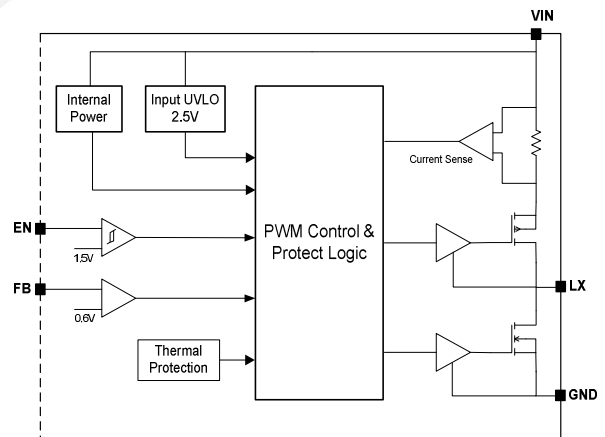

### Ordering Information

Order Part Number	Top Marking		$T_A$	Package	
DIO6002CST5	CYWN	Green	-40 to +85°C	SOT23-5	Tape & Reel, 3000

#### Marking Definition

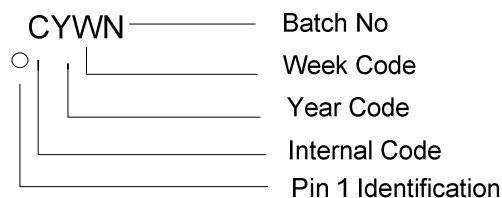

## Pin Assignments

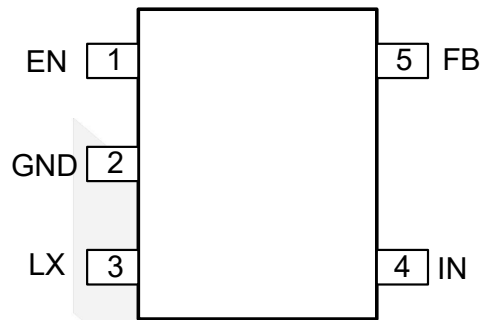

SOT23-5

Figure 1 Pin Assignment (Top View)

## Pin Definitions

Pin Name	Description
EN	Enable control. Pull high to turn on. Do not float.
GND	Ground
LX	Inductor pin. Connect this pin to the switching node of inductor.
IN	Power Input
FB	Output Feedback Pin. Connect this pin to the center point of the output resistor divider (as shown in Figure 1) to program the output voltage: $V_{OUT} = 0.6 * (1 + R1/R2)$ . Add optional C1 (10pF~47pF) to speed up the transient response.





## DIO6002

High-Efficiency 1.5MHz, 1.2A Continuous, 1.5A Peak Synchronous Step Down Converter

### Absolute Maximum Ratings

Stresses beyond those listed under “Absolute Maximum Rating” may cause permanent damage to the device. These are stress ratings only and functional operation of the device at these or any other condition beyond those indicated in the operational sections of the specifications is not implied. Exposure to absolute maximum rating conditions for extended periods may affect device reliability.

Parameter	Rating	Unit	
Supply Voltage ( V+ – V-)	6.0	V	
Enable, FB Voltage	$V_{IN}+0.2$	V	
Power Dissipation, $P_D$ @ $T_A = 25^\circ\text{C}$ , SOT23-5	0.6	W	
Package Thermal Resistance	$\theta_{JA}$ , SO23-5	170	$^\circ\text{C/W}$
	$\theta_{JC}$ , SO23-5	130	
Storage Temperature Range	-65 to 150	$^\circ\text{C}$	
Junction Temperature Range	150	$^\circ\text{C}$	
Lead Temperature Range	260	$^\circ\text{C}$	
ESD	HBM, JEDEC: JESD22-A114	4000	V
	MM, JEDEC: JESD22-A115	200	
Dynamic LX Voltage in 50ns Duration	$V_{IN}+3$ to GND-4	V	

### Recommend Operating Conditions

The Recommended Operating Conditions table defines the conditions for actual device operation. Recommended Operating conditions are specified to ensure optimal performance to the datasheet specifications. DIOO does not Recommend exceeding them or designing to Absolute Maximum Ratings.

Parameter	Rating	Unit
Supply Voltage	2.5 to 5.5	V
Junction Temperature Range	-40 to 125	$^\circ\text{C}$
Ambient Temperature Range	-40 to 85	$^\circ\text{C}$



# DIO6002

High-Efficiency 1.5MHz, 1.2A Continuous, 1.5A Peak Synchronous Step Down Converter

## Electrical Characteristics

$V_{IN} = 5V$ ,  $V_{OUT} = 1.8V$ ,  $L = 2.2\mu H$ ,  $C_{OUT} = 10\mu F$ ,  $T_A = 25^\circ C$ , unless otherwise specified.

Symbol	Parameter	Test Conditions	Min	Typ	Max	Unit
$V_{IN}$	Input Voltage Range		2.5		5.5	V
$I_Q$	Quiescent Current	$I_{OUT}=0$		40		$\mu A$
$I_{SHDN}$	Shutdown Current	$EN=0$		0.1	1	$\mu A$
$V_{REF}$	Feedback Reference Voltage		0.588	0.6	0.612	V
$R_{DS(ON),P}$	PFET $R_{ON}$			230		$m\Omega$
$R_{DS(ON),N}$	NFET $R_{ON}$			170		$m\Omega$
$I_{LIM}$	PFET Current Limit		1.8			A
$V_{ENH}$	EN Rising Threshold		1.5			V
$V_{ENL}$	EN Falling Threshold				0.4	V
$V_{UVLO}$	Input UVLO Threshold				2.4	V
$V_{HYS}$	UVLO Hysteresis			0.3		V
$F_{OSC}$	Oscillator Frequency	$I_{OUT}=500mA$		1.5		MHz
	Min ON Time			80		ns
	Max Duty Cycle		100			%
$T_{SS}$	Soft Start Time			1		ms
$T_{SD}$	Thermal Shutdown Temperature			150		$^\circ C$
$T_{HYS}$	Thermal Shutdown Hysteresis			20		$^\circ C$

## Typical Application

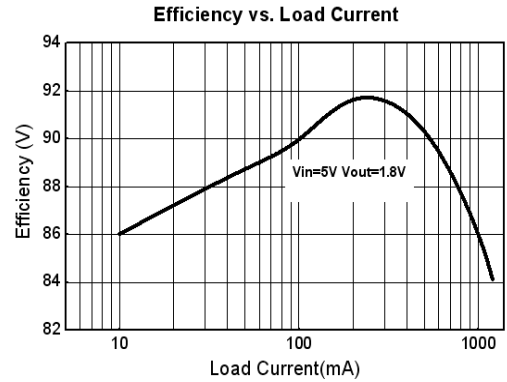
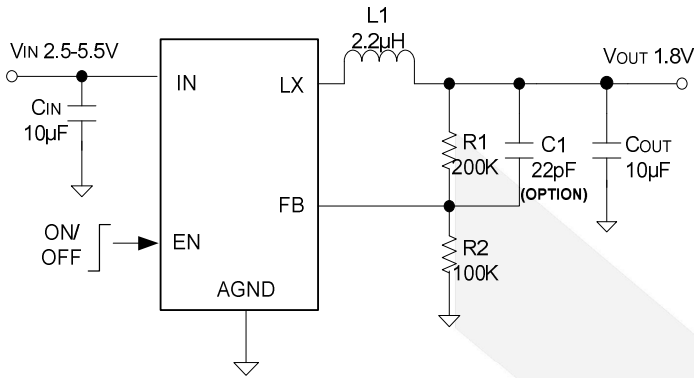

## Typical Performance Characteristics

$V_{IN} = 5V$ ,  $V_{OUT} = 1.8V$ ,  $L = 2.2\mu H$ ,  $C_{IN} = 10\mu F$ ,  $C_{OUT} = 10\mu F$ ,  $T_A = 25^\circ C$ , unless otherwise noted.

**Start up from Vin**  
(Iload=1.2A)

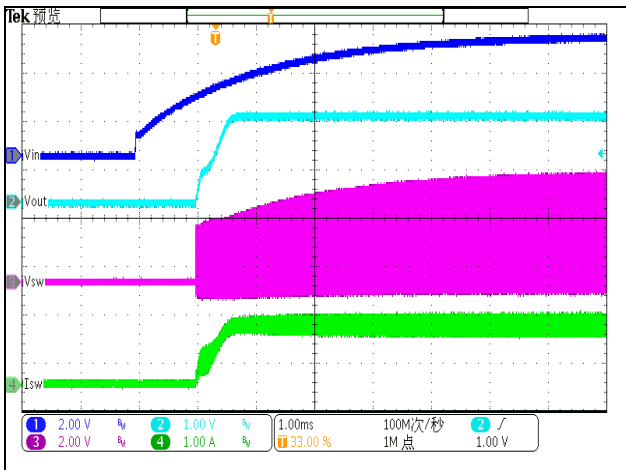

**Shut down from Vin**  
(Iload=1.2A)

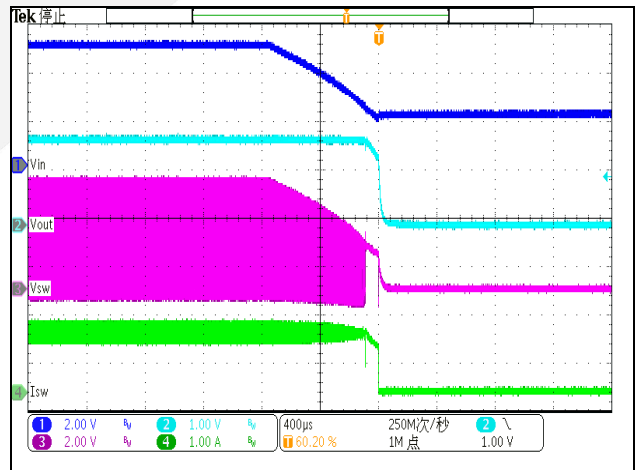

**Start up from Enable**  
(Iload=0.6A)

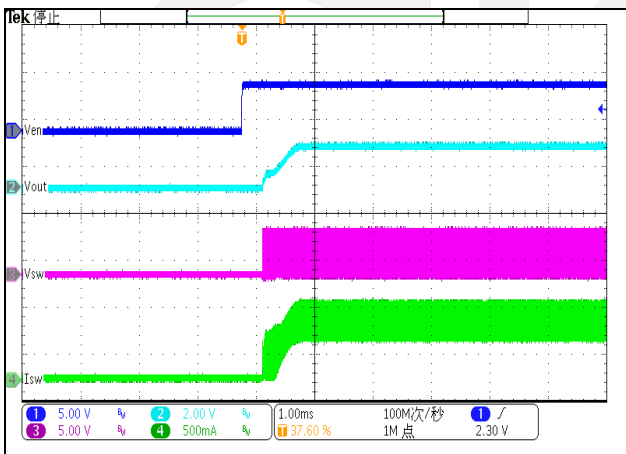

**Shut down from Enable**  
(Iload=0.6A)

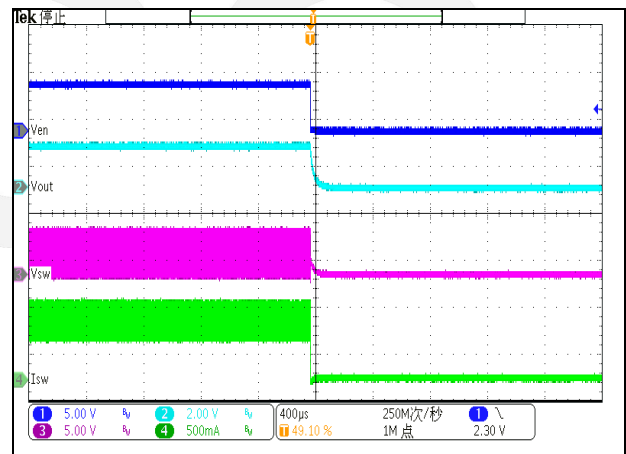

**Load transient**  
(Iload=0.1-1.2A)

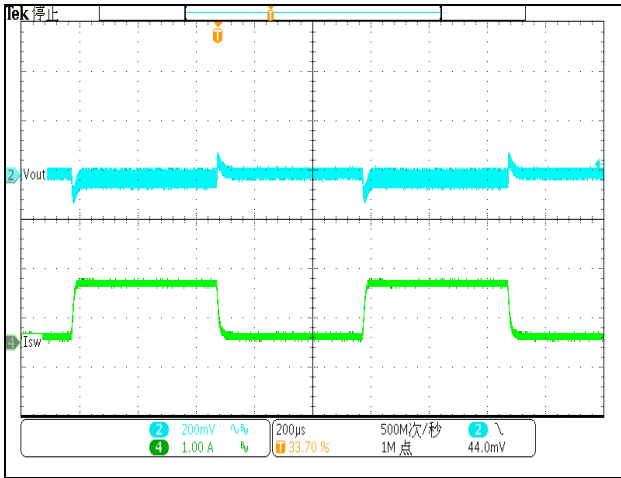

**Load transient**  
(Iload=0.6-1.2A)

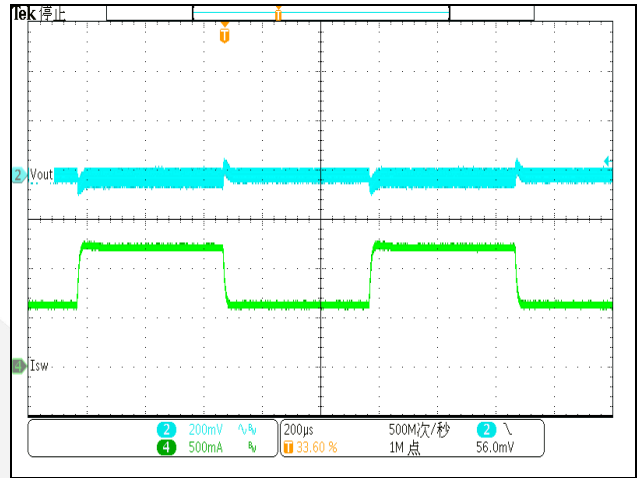

**Ripple**  
(Iload=0A)

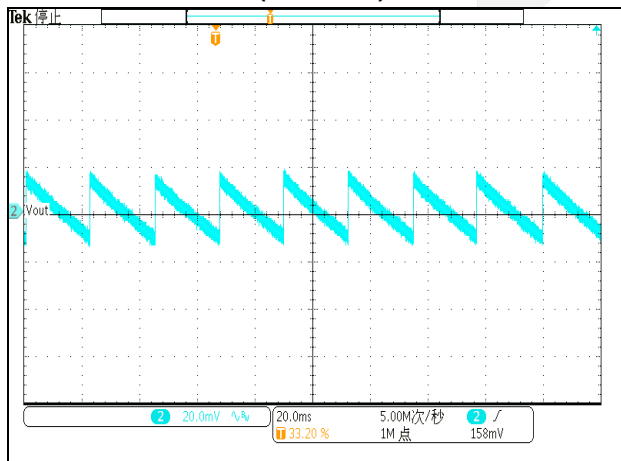

**Ripple**  
(Iload=1.2A)

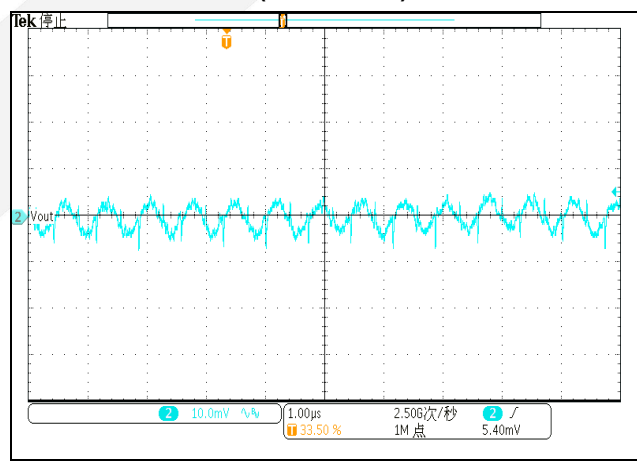

**Short Circuit Protection**  
(Iload=0A)

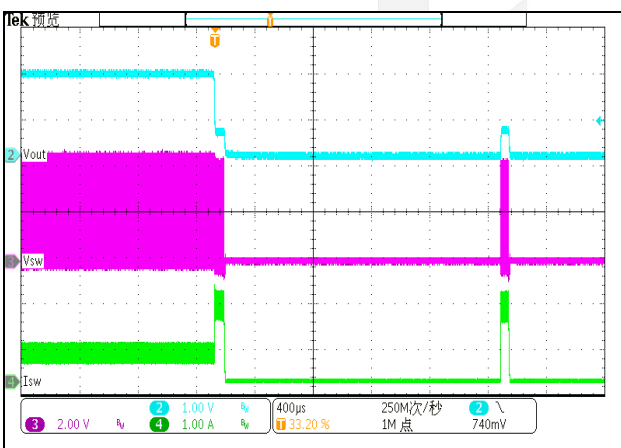

**Short Circuit Recovery**  
(Iload=0A)

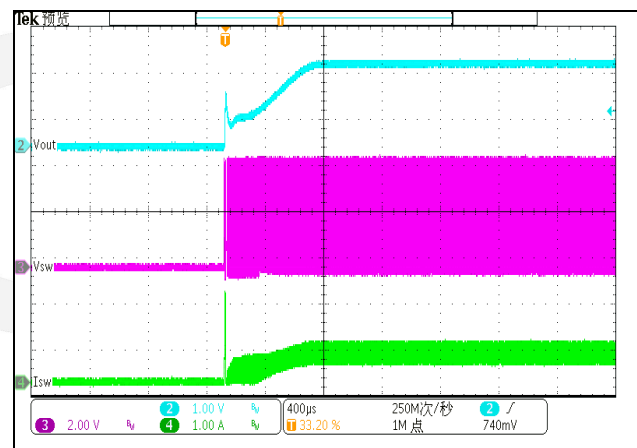

## CONTACT US

Dioo is a professional design and sales corporation for high-quality and performance analog semiconductors. The company focuses on industry markets, such as, cell phone, handheld products, laptop, and medical equipment and so on. Dioo's product families include analog signal processing and amplifying, LED drivers and charger IC. Go to <http://www.dioo.com> for a complete list of Dioo product families.

For additional product information, or full datasheet, please contact with our Sales Department or Representatives.

